

**170095 Dimensions**

Overall Width w/ Trim: 24-3/8"  
(Rough Opening: 22-1/8")

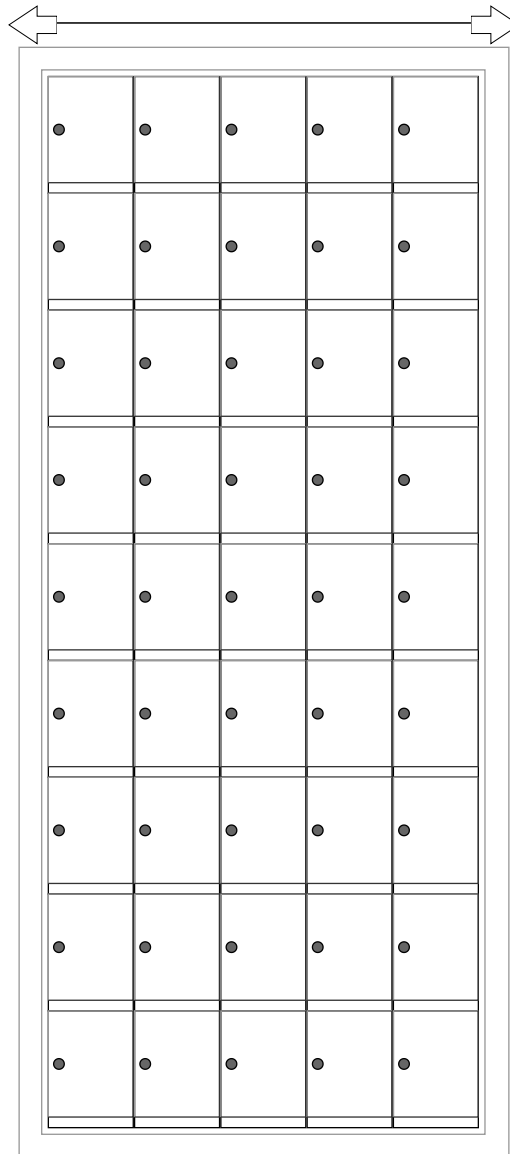

170095

**Side View**

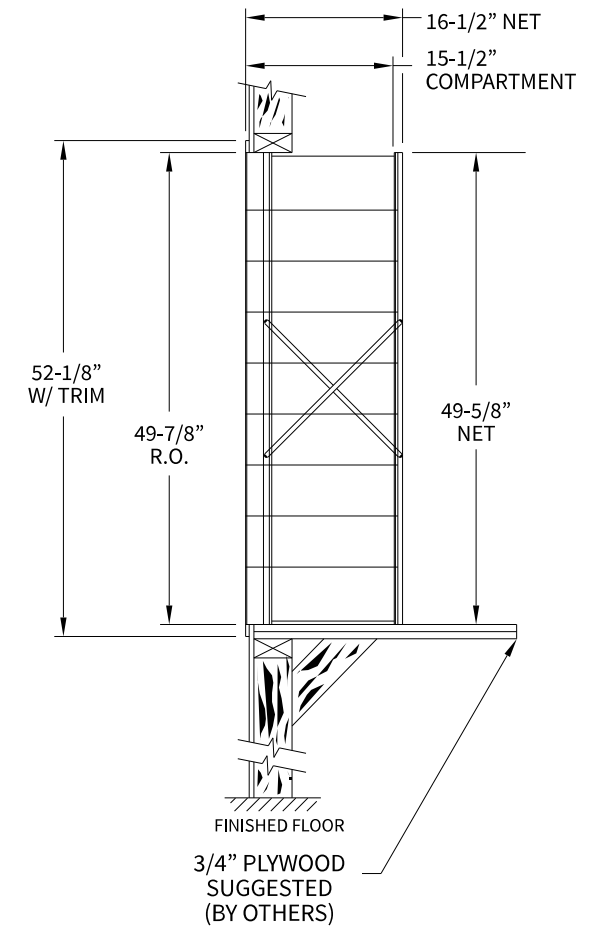

**Configuration Details:**

- 1. **Product Type:** 1700 Horizontal
- 2. **Installation:** Rear-load, Recessed Mount
- 3. **Finish:** Anodized Aluminum
- 4. **Locks:** Standard Cam Lock, 2 keys
- 5. **Door Id:** tbd
- 6. **Rear Cover:** tbd

Matching standard snap-on trim included

**Models Used:**

(1) 170095

**DO NOT SCALE OFF DRAWING**

**Door Sizes Used:**

(45) 1700 1x1 Compartment

**ELEVATION:** 170095 | **MAILBOXES:** 45 |

**PROJECT NAME:** 1700 Series Mailbox | **DRAWN BY:** FLORENCE

**AF FLORENCE**  
manufacturing company

5935 Corporate Drive • Manhattan, KS 66503  
www.florencemailboxes.com • 800.275.1747

A GIBRALTAR INDUSTRIES COMPANY

**DATE:** 01-15-2016 | **P.O. NO:**

**SCALE:** NONE | **QUOTE NO:**

**DRAWING NO.** WEB-1932 | **SHEET 1 OF 1**