

Versatile™ 4C Pedestal Mount Collection Box, 4C16S-HOP-P

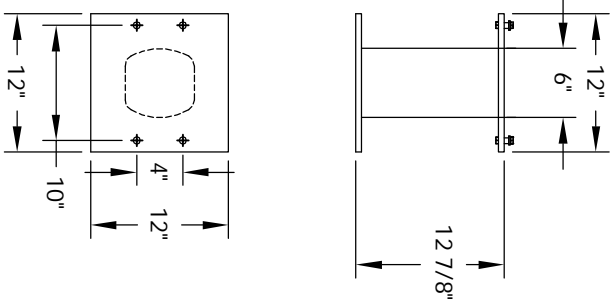

PEDESTAL DETAIL

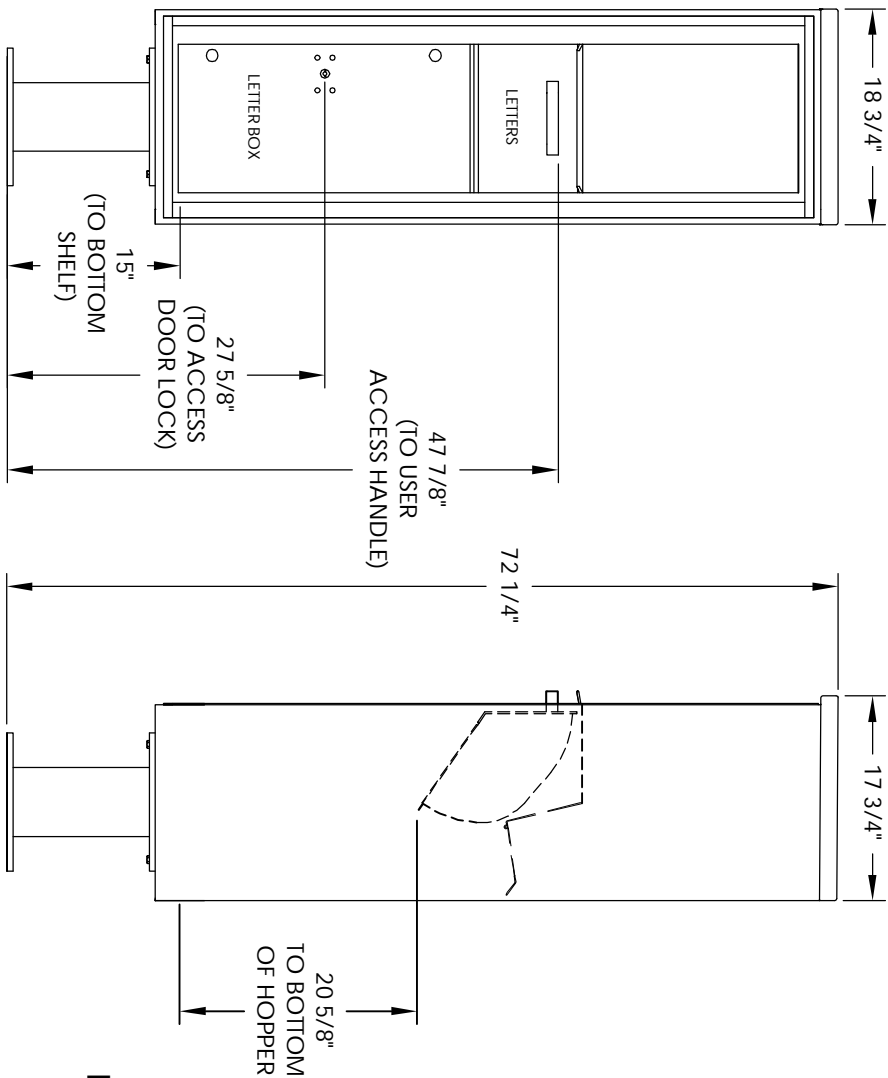
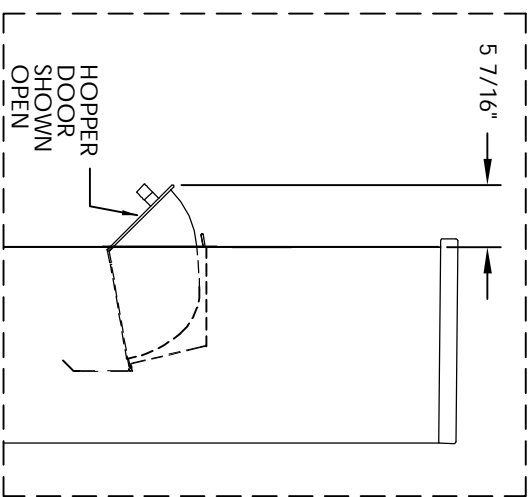

MAX BUNDLE SIZE			
HEIGHT	WIDTH	LENGTH	
4 1/4"	11 3/8"	6 1/4"	
3 1/2"	11 3/8"	11 1/2"	
3"	11 3/8"	14 3/4"	
2 1/2"	11 3/8"	14 3/4"	

- NOTES:
1. 4C pedestal units are for private applications only / not USPS Approved.
 2. May be installed outside or inside - see foundation specification details within the 4C Installation Manual.
 3. Collection Box compartment size is 20 5/8" H x 12" W x 15"D.
 4. Fixed top panel is for security purposes and is not usable.

PRODUCT SERIES: VERSATILE™ 4C PEDESTAL MOUNT COLLECTION BOX

AF FIORENCE
manufacturing company
 5935 Corporate Drive • Manhattan, KS 66503
 www.fiorenceanmailboxes.com • (800) 275-1747
 A GIBRALTAR INDUSTRIES COMPANY

MODEL	REV	SCALE	DRAWING NUMBER	LAST REV DATE	DRAWN BY
4C16S-HOP-P	C	NONE	4C16S-HOP-PCS	7/02/14	TNS