

Versatile™ 4C Collection Box, 4C09S-HOP

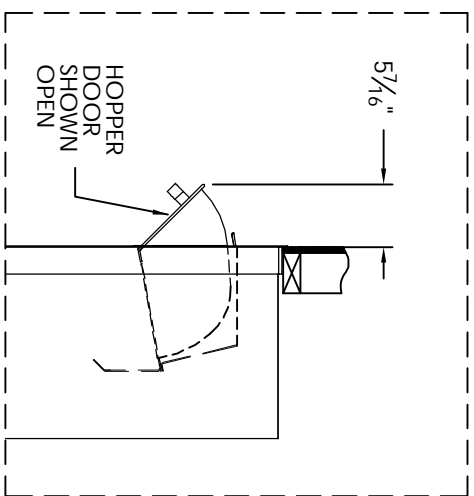
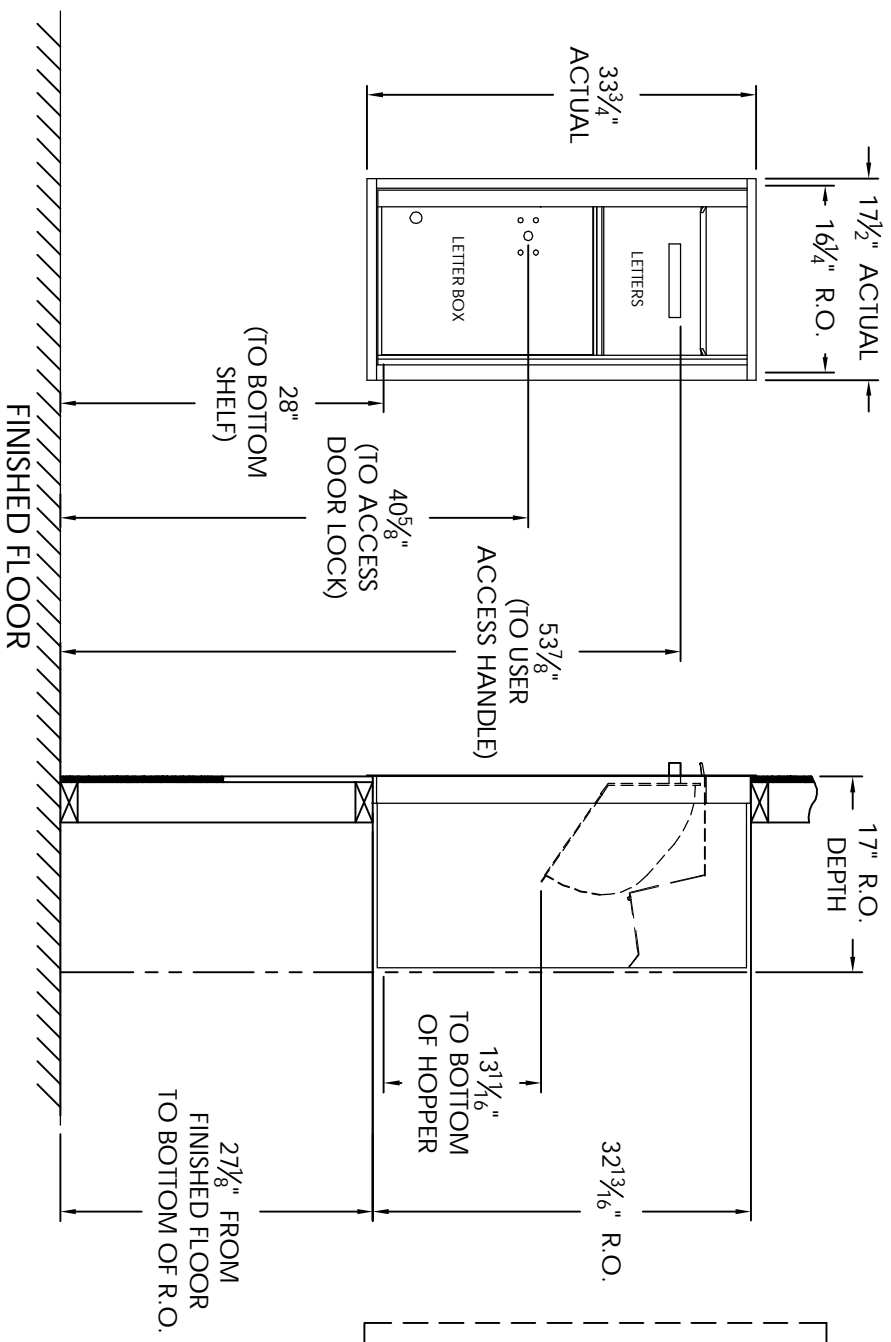

MAX BUNDLE SIZE			
HEIGHT	WIDTH	LENGTH	
4 1/4"	11 3/8"	6 1/4"	
3 1/2"	11 3/8"	11 1/2"	
3"	11 3/8"	14 3/4"	
2 1/2"	11 3/8"	14 3/4"	

- NOTES:
1. 4C Collection boxes are USPS Approved.
 2. Module may be recessed, surface, or pedestal mounted and coordinates with Florence versatile™ 4C mailbox modules, see installation manual for details.
 3. Collection Box compartment size is 13 11/16" H x 12" W x 15"D.
 4. Fixed top panel is for security purposes and is not usable.

PRODUCT SERIES: VERSATILE™ 4C COLLECTION BOX

AF FLORENCE
 manufacturing company
 5935 Corporate Drive • Manhattan, KS 66503
 www.florencemailboxes.com • (800) 275-1747
 A GIBRALTAR INDUSTRIES COMPANY

MODEL	4C09S-HOP	REV	D
SCALE	NONE	LAST REV DATE	7/03/2014
DRAWING NUMBER	4C09S-HOPCS	DRAWN BY	TNS