

140052 Dimensions

Overall Width w/ Trim: 16-7/8"
(Rough Opening: 14-5/8")

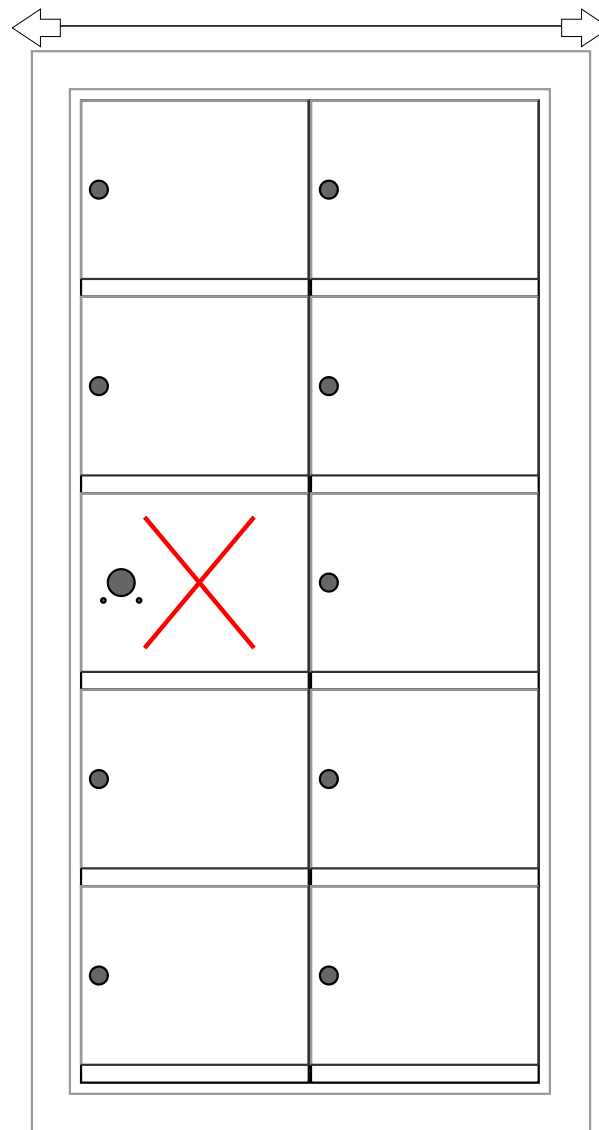

140052

Side View

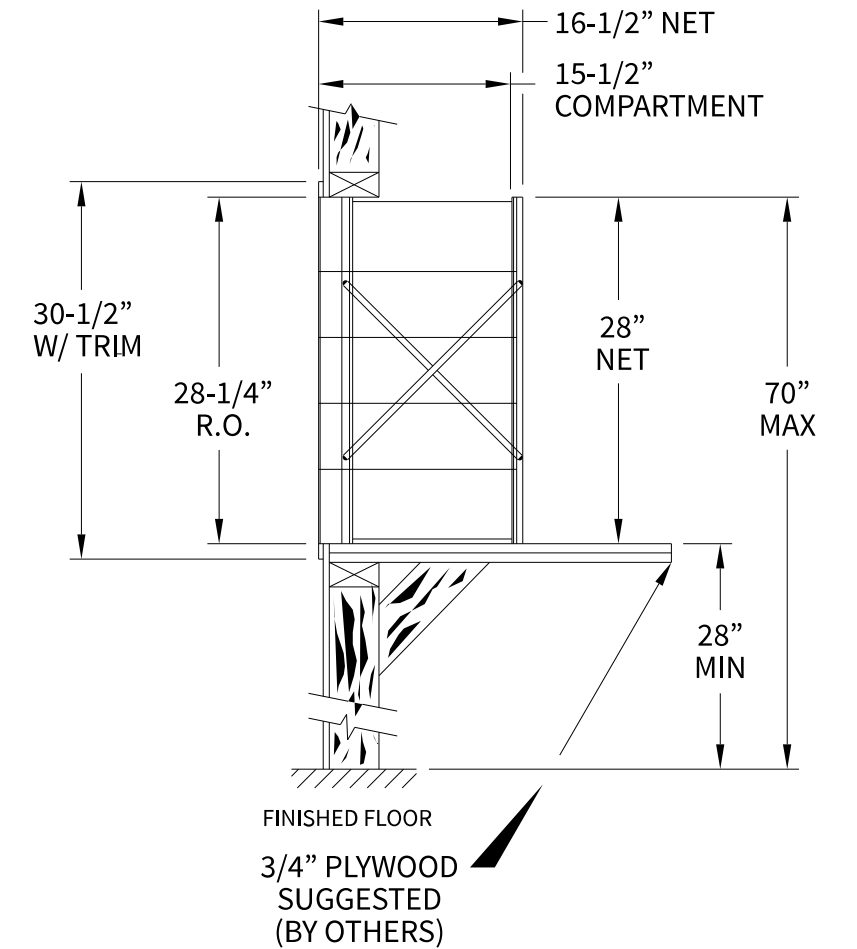

Configuration Details:

- 1. **Product Type:** 1400 Horizontal
- 2. **Installation:** Front-load, Recessed Mount
- 3. **Finish:** Anodized Aluminum
- 4. **Locks:** Standard Cam Lock, 2 keys
- 5. **Door Id:** tbd
- 6. **Master Door:** tbd

Matching standard snap-on trim included

Models Used:

(1) 140052

DO NOT SCALE OFF DRAWING

Door Sizes Used:

(9) 1400 1x1 Compartment
(1) 1x1 Master

ELEVATION: 140052 | **MAILBOXES:** 9 |

PROJECT NAME: 1400 Series Mailbox | **DRAWN BY:** FLORENCE

AF FLORENCE
manufacturing company

5935 Corporate Drive • Manhattan, KS 66503
www.florencemailboxes.com • 800.275.1747

A GIBRALTAR INDUSTRIES COMPANY

DATE: 01-15-2016	P.O. NO:
SCALE: NONE	QUOTE NO:
DRAWING NO. WEB-1932	SHEET 1 OF 1